

# August Workbay

Available at  
**pCon**  
PLANNER

## Sound-absorbing workstation

Design: Pent Talvet, Iseasi

Looking for the perfect spot to have that important conversation? The August sofa set provides an easy solution for creating a workbay where you can go to get some privacy or have meetings. The August Workbay is an integral part of your Concentration Zone, providing an opportunity to step away from the noise, and find the focus you need.

The only thing it takes is to connect two August sofas or armchairs with a partition wall. Sound-absorbing qualities make it easy to carve out a space of peace and quiet within an open-plan office. Distraction-busting high sides with sound-absorbing qualities make it easy to carve out a space of peace and quiet within an open-plan surroundings.



Collaboration Zone



Concentration Zone

Divide your space organically

Cut down on background noise

Hold your own private meeting

Give the option of focus and seclusion

## PRODUCT INFORMATION

### Versions

Available in 2 different heights and 4 different sizes

### Acoustics

Sound absorption class A

### Accessories

Additional tables to add functionality to the seating area

### Electrical outlet

Integrated in the PC and TV wall

### Warranty

5 years

### Sustainability

Embraces the principles of circular design

### Test & Certification

- L1 European Standard strength, durability and safety certificate
- Acoustic absorption test - Class A



## STANDARD MATERIALS

### Frame

Solid wood and plywood

### Seat & backrest

Durable HR foam; fire retardant HR foam on request; fixed seat and back cushions

### Wall fastenings

Powder-coated metal

### Legs

Solid oak / Powder-coated metal

### Tables

Matt high-pressure laminate, or mass-colored wood fibreboard top with matt powder-coated metal legs

### Fabric upholstery

The cover material is not removable

Sides and rear wall of H3 models can exclusively be covered with felt fabric only

Choose any fabric from **Intuit Standard Fabric Collection**

### Additional information

As part of after-sales service we offer the change of cover fabric and all other components if needed



## LEGS







Solid oak legs, stained and varnished; anti-slip soles



Matt powder-coated metal legs; anti-slip soles

### Solid oak

Whitened	
Natural	
Wenge	
Black	

Other finishing options available on request.

### Powder-coated metal

Jet Black RAL 9005	
--------------------	---

## ELECTRICAL OUTLET

### Integrated in the PC wall

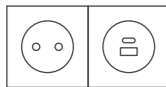

220V + USB A & C



**Berker Integro Flow**  
Color: Anthracite Matt

Available options DK, EU, FR, UK

### Integrated in the TV wall

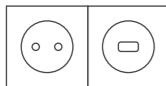

220V + HDMI



**Berker Integro Flow**  
Color: Anthracite Matt

Available options DK, EU, FR, UK

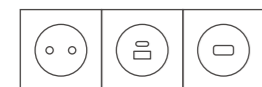

220V + USB A & C + HDMI

Other electrical outlet combinations available on request.





## TABLES



Aide cafeteria / work tables



### Aide tabletop

#### High-pressure laminate

Alpine White Egger W1100 PM	
Soft Black Egger U899 PM	
Stone Green Egger U665 PM	
Garnet Red Egger U399 PM	

### Aide table legs

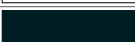
#### Powder-coated metal

Signal White RAL 9003	
Jet Black RAL 9005	
Tarpaulin Grey RAL 7010	
Black Red RAL 3007	

Other finishing options available on request.



August table with plywood edge

### August tabletop

#### High-pressure laminate, plywood edge

Black	
-------	---

#### Mass-colored wood fibreboard

Grey	
Black	

### August table frame

#### Powder-coated metal

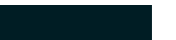
Jet Black RAL 9005	
--------------------	---

Payfit office in Paris, France

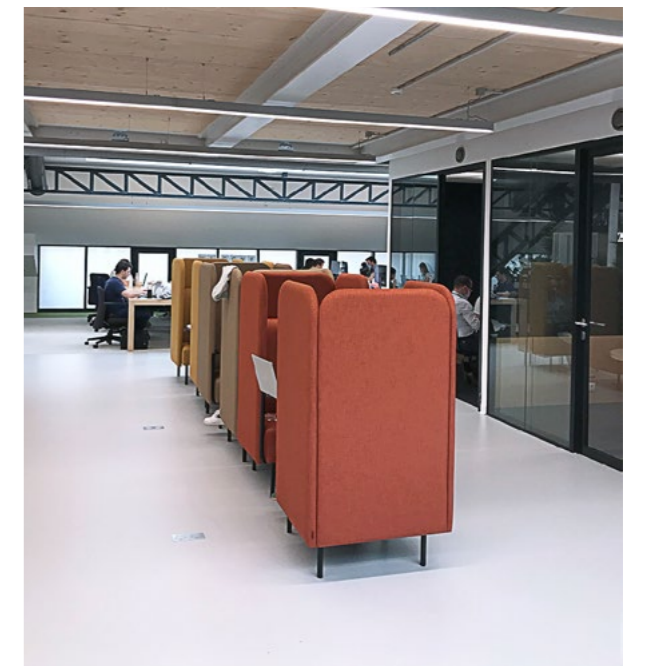

## DIMENSIONS

### Workbay

Seat depth: 48 cm / Seat height: 45 cm

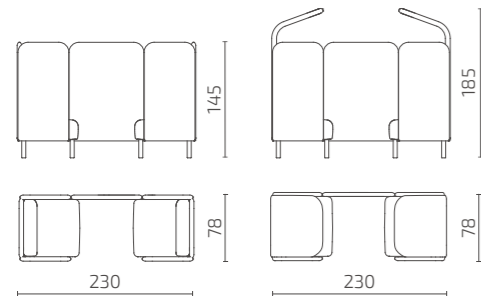

**S101-WS1H2**

**S101-WS1H3**

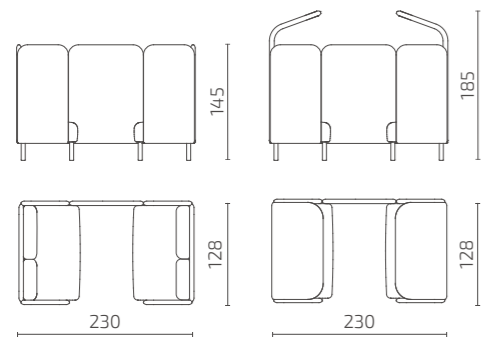

**S101-WS2H2**

**S101-WS2H3**

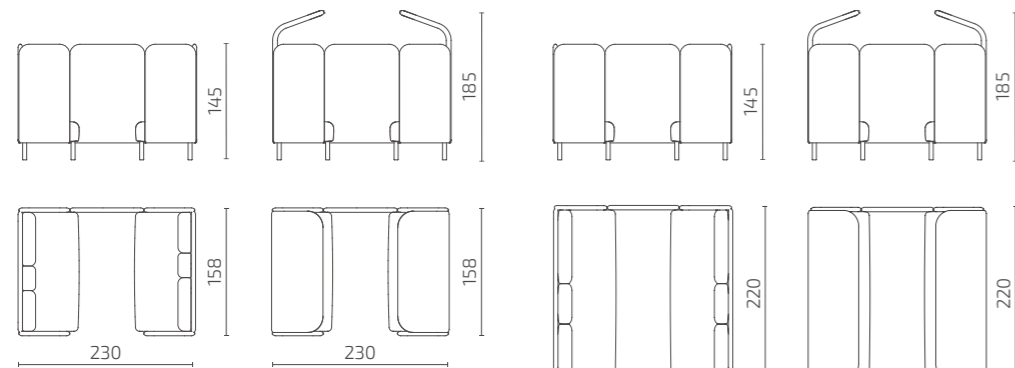

**S101-WS25H2**

**S101-WS25H3**

**S101-WS3H2**

**S101-WS3H3**

### Workbay wall

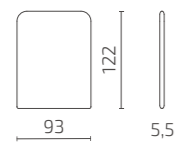

Regular wall

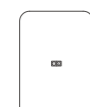

**S101-ELPC**  
PC integrated  
electrical outlet



**S101-ELTV**  
TV integrated  
electrical outlet

All dimensions provided in centimetres.

### Tables



**S128-T4M**  
AIDE table



**S128-T1M**  
AIDE table



**S128-T3M**  
AIDE table



**S101-T1**  
AUGUST table



**S101-T3**  
AUGUST table

## PRICE LIST

Currency: € (VAT incl.)

PRODUCT NAME	CODE	COM/ PWF*	FABRIC CONS.	FABRIC 1	FABRIC 2	FABRIC 3	FABRIC 4	FABRIC 5
AUGUST Workbay 1-Seat H2	<b>S101-WS1H2</b>	3280	16,2	3439	3765	4120	4595	5069
AUGUST Workbay 1-Seat H3	<b>S101-WS1H3</b>	4378	17,6	4550	4904	5291	5806	6322
AUGUST Workbay 2-Seat H2	<b>S101-WS2H2</b>	4308	20,4	4507	4918	5366	5963	6560
AUGUST Workbay 2-Seat H3	<b>S101-WS2H3</b>	5450	22,8	5673	6132	6633	7300	7968
AUGUST Workbay 2,5-Seat H2	<b>S101-WS25H2</b>	4543	23,6	4774	5249	5767	6458	7149
AUGUST Workbay 2,5-Seat H3	<b>S101-WS25H3</b>	6308	26,8	6569	7109	7697	8482	9267
AUGUST Workbay 3-Seat H2	<b>S101-WS3H2</b>	5767	28,4	6045	6616	7240	8072	8903
AUGUST Workbay 3-Seat H3	<b>S101-WS3H3</b>	7187	32,8	7507	8167	8888	9848	10808

\* Customer's Own Material / Price Without Fabric

TABLES	CODE	PRICE
AIDE cafeteria/work table (60x60x72 cm)	<b>S128-T4M</b>	336
AIDE cafeteria/work table (110x60x72 cm)	<b>S128-T1M</b>	469
AIDE cafeteria/work table (139x60x72 cm)	<b>S128-T3M</b>	476
AUGUST work table (80x36x70 cm)	<b>S101-T1</b>	272
AUGUST work table (110x55x70 cm)	<b>S101-T3</b>	359

WALL WITH ELECTRICAL OUTLET	CODE	PRICE
PC integrated electrical outlet	<b>S101-ELPC</b>	315
TV integrated electrical outlet	<b>S101-ELTV</b>	434

# SOUND-ABSORBING FURNITURE

Public space and open offices often have problems with resonance, meaning that sounds reverberate for too long. Sound waves cannot move freely in a closed room and bounce off the structure of the room. Some of the sound is absorbed by surfaces, while some reflects from them.

Monitoring sound absorption and achieving the recommended reverberation duration is one of the principal tasks in the acoustic design of rooms. Acoustic absorption means that sound does not reflect off a material after reaching it. That is also the principle of designing furniture with acoustic properties: furniture has to absorb the sound that would otherwise reflect back and contribute to unwelcome noise.

Creating a more pleasant environment requires us to dampen all kinds of different sounds, such as fans, people's footsteps, conversations and phone calls.

## **Acoustic August**

The entire August series is designed to improve office acoustics which makes it a perfect choice for an intuitive workplace. August product series gives you more absorption area in the room, e.g. better sound and less reverberance. A less reverberant room gives you better speech quality and less noise in the work environment.

The August products are rated at the highest Class A for sound attenuation. This means that they offer noise reduction equivalent to covering additional square meters of a room with 100% sound-absorbing material. The specific amount of square meters covered depends on the surface area of the chosen August model.

THE AUGUST PRODUCTS ARE RATED  
AT THE HIGHEST CLASS A  
FOR SOUND ATTENUATION



### Equivalent absorption area per object (m<sup>2</sup>Sab / object)

For example, the calculated sound absorption value for the August 2.5-Seat/H3 sofa model is 4.8m<sup>2</sup>/sab. This is comparable to completely covering an area of 4.8 m<sup>2</sup> with a material that absorbs 100% of sound. In practical terms, one August 2.5-Seat/H3 sofa provides the same noise reduction as about 12-13 sound absorber walls, each 50mm thick and covered with cloth or felt, measuring 600x600 mm.

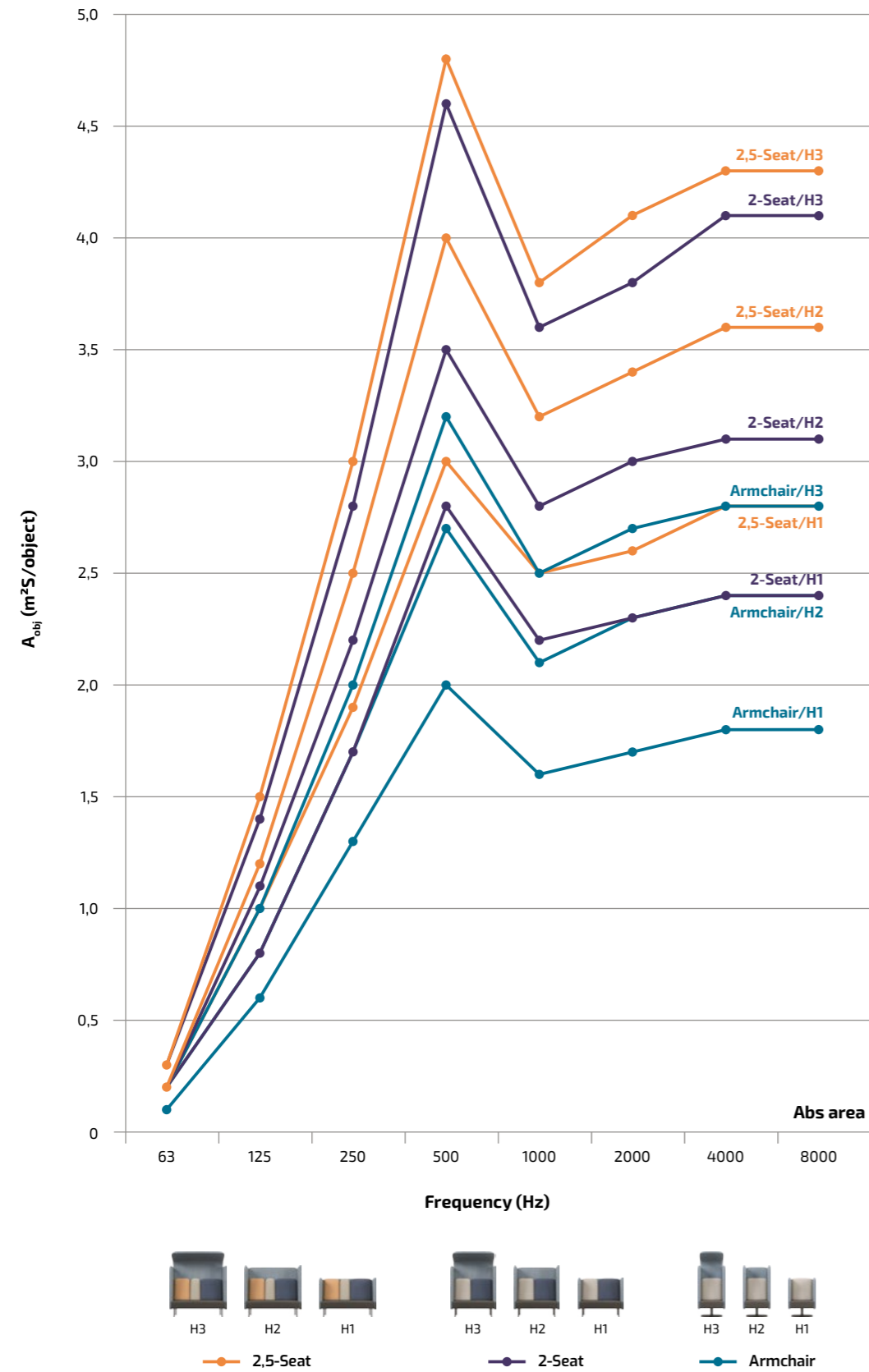

### Equivalent absorption area per object (m<sup>2</sup>Sab / object)

For example, the calculated sound absorption value for the August Workbay 2.5-Seat/H3 model is 10.7m<sup>2</sup>/sab. This is comparable to completely covering an area of 10.7 m<sup>2</sup> with a material that absorbs 100% of sound. In practical terms, one August Workbay 2.5-Seat/H3 provides the same noise reduction as about 29-30 sound absorber walls, each 50mm thick and covered with cloth or felt, measuring 600x600 mm.

